



Healthcare Lookbook



Storage Solved®

Hello, we're Spacesaver. Pleased to meet you.

We have grown from being only a high-density mobile storage and shelving provider to the leading manufacturer of a wide variety of storage products, from lockers to weapons racks to modular bin shelving and all things in between.



Spacesaver was founded in 1972 by Theodore W. Batterman in the small town of Fort Atkinson, Wisconsin. Ted's mission was to help organizations maximize space, save energy, and increase productivity, and he realized that high-density mobile storage could accomplish all three goals at once. Working out of a barn with only seven employees, he spearheaded the development of high-density mobile storage and shelving for the United States.

Spacesaver's client base has expanded dramatically since those early days, and today we've completed more than 300,000 installations in the U.S. and around the world. Our clients include a wide variety of organizations, from manufacturers to military bases to museums. In 1998 Spacesaver became part of KI, an employee-owned global company headquartered in Green Bay, Wisconsin, that was founded in 1941.

Our team of in-house engineers, project managers, and skilled manufacturers work with our extensive network of authorized distributors to provide our clients with well-designed, reliable, and aesthetically pleasing storage solutions.

We look forward to working with you.

Storage. On Site. In Sight. At Hand.

On the pages that follow, you'll be introduced to storage solutions in Spacesaver's healthcare product line. You'll also see those products in action through real-life case studies in hospitals, pharmacies, and more.

We could have designed a book of product brochures, but that would only show you the core functions of our product—not how Spacesaver silently adds value to your healthcare facility. Or, we could have put together a guide full of technical drawings—but that would only show you the bare bones of our product, not the application.

Think of this book as a guide to understanding how storage impacts your daily functions. Our goal is to share our insights into what is needed most when it comes to storage, and partner with you to create a solution that works in tandem with your facility's needs.

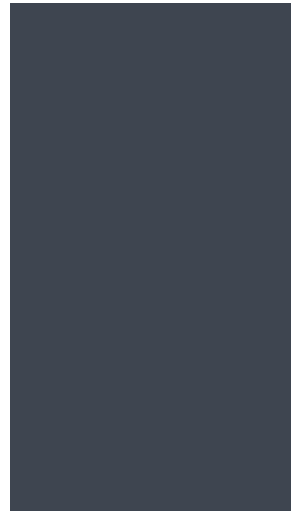

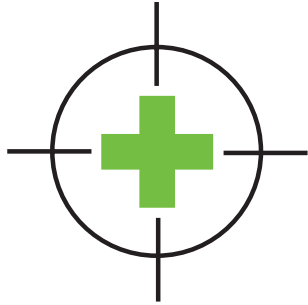
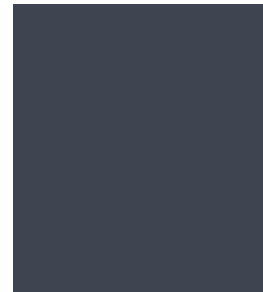

Table of Contents

Healthcare: The Products	9
Products: High-Density Mobile Storage	11
Products: Modular Storage Systems	14
Products: Personal Storage Lockers	16
Healthcare: The Applications	19
Applications: Operating Room and Procedures Storage	20
Operating Room and Procedures Storage: Drexel University College of Medicine	21
Operating Room and Procedures Storage: Peninsula Regional Medical	22
Operating Room and Procedures Storage: Kennestone Regional Medical Center	23
Applications: Pharmacy Storage	24
Pharmacy Storage: Utah State Hospital	25
Pharmacy Storage: Peterborough Medical Center	26
Applications: Sterile Supply Storage	27
Sterile Supply Storage: Atrium Medical Center	29
Sterile Supply Storage: Virginia Hospital	30
Sterile Supply Storage: Naval Medical Center	31
Creating a Partnership	33





HEALTHCARE:

THE PRODUCTS

HIGH-DENSITY MOBILE STORAGE

Store more medical supplies in less space.

What is high-density mobile shelving?

Think about the stationary or static shelving in your sterile storage areas or pharmacies. It's shelving that does what it needs to do—but the challenge is that it takes up a fixed amount of space, and that fixed space includes wasted aisles. Meanwhile, we're willing to bet that the amount of supplies and inventory you need to store keeps increasing, while the available square footage you have to store these items stays exactly the same.

High-density mobile shelving (HDMS) eliminates those fixed aisles, creating moveable aisles that compact your storage space. By placing the shelving and carriages on moveable rails, HDMS delivers the same capacity as static shelving in half the floor space—or, to flip the scenario, it can allow you to double the storage capacity of your existing floor space.



High-Density Mobile Storage Applications:

- Operating Room/Surgical Storage
- Climate-Controlled Areas
- Pharmaceutical Storage
- Records Storage
- Clean and Sterile Environments

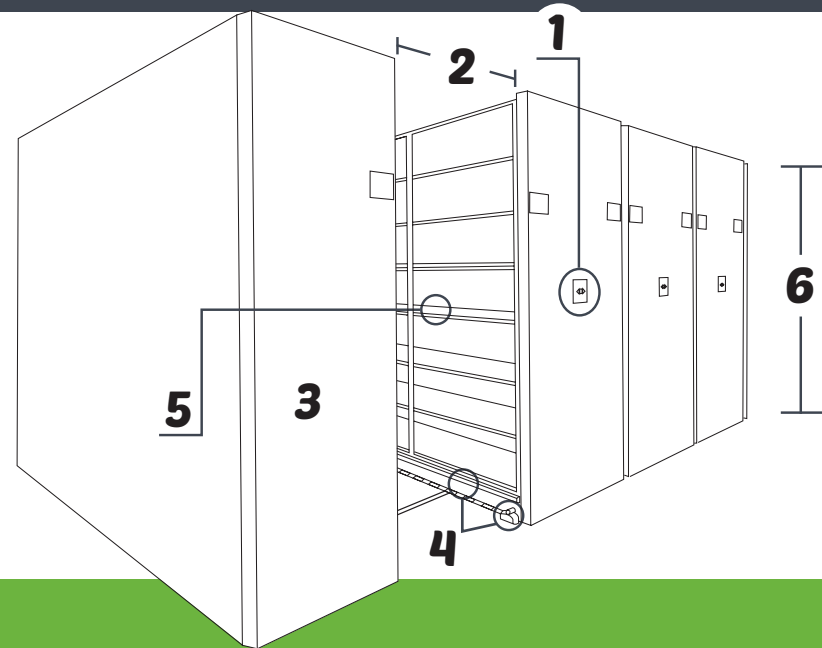

Available Features Include:

- 1. Controls:** Choice of Manual, Mechanical-Assist, or Powered controls (Touchpad or LCD Touchscreen Technology). The Touchpad or Touchscreen can be helpful in assisting with the protection of medical health records in accordance with the HIPAA Privacy Rule.
- 2. Aisle Widths:** Aisle widths can be made flexible to fit the needs of your pharmacy, sterile supply area, or procedures storage.
- 3. Face Panels:** Available in extensive choices of colors and finishes in laminates, wood veneer, and steel.
- 4. Safety Options:** Concerned about safety? We are, too. That's why we offer multiple options when it comes to the use, entry, and operation of our mobile shelving systems.
- 5. Shelving:** We offer adjustable 4-post, case-type, and wire shelving that integrates into our mobile storage units, although our systems are designed to accommodate virtually any kind of new or existing shelving, cabinets, or other storage housing.
- 6. Heights:** Shelving heights can be made flexible to meet the needs of your healthcare facility.
- 7. Rail Options:** Choice of surface-mount or recessed rail, and choice of types of rails (including stainless steel rails, which can mount directly to the floor, eliminating the need for plywood decking to help with infection control in a healthcare environment).

How High-Density Mobile Shelving Saves Space.

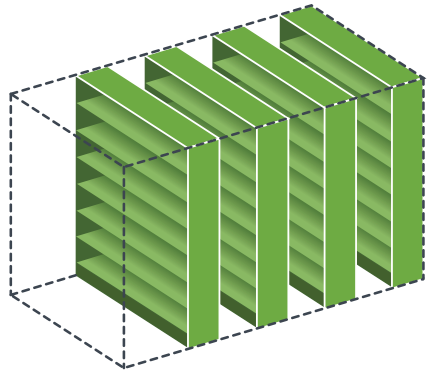

Traditional shelving
WASTES SPACE.

With traditional static shelving, a large percentage of floor space is wasted in aisles.

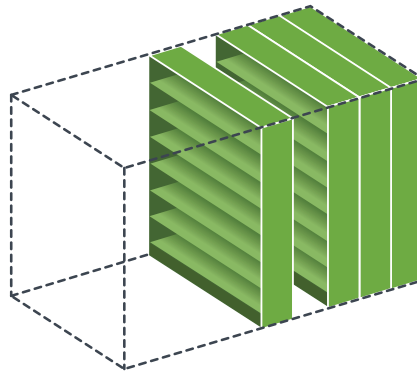

Mobile shelving
INCREASES SPACE.

Mobile shelving delivers the same capacity as static shelving in half the floor space.

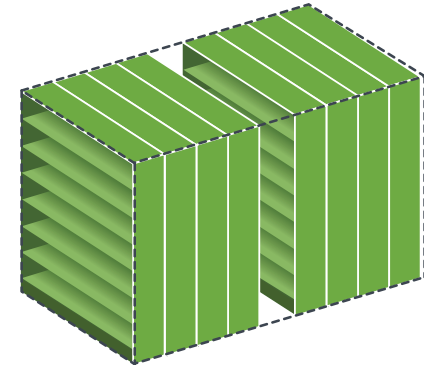

Mobile shelving
DOUBLES CAPACITY.

Mobile shelving allows you to double the storage capacity of your existing floor space.

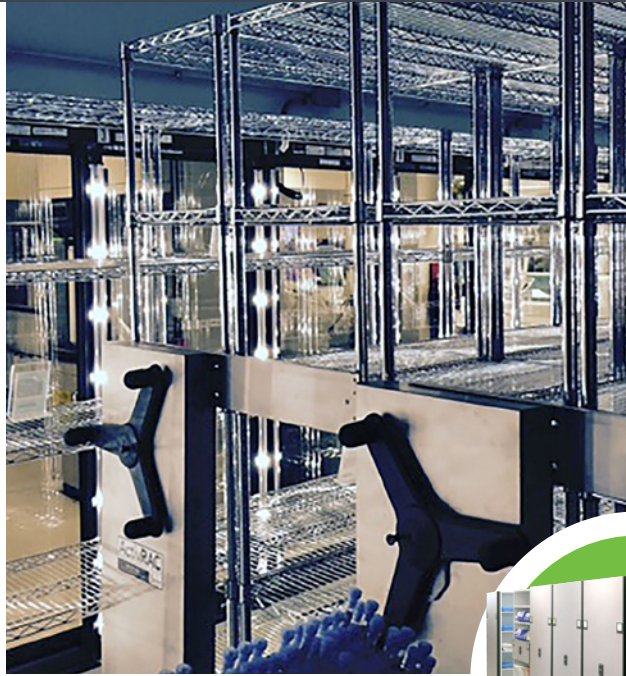

MODULAR STORAGE SYSTEMS

Change your storage.
As often as you'd like.

Count on the FrameWRX® Modular Storage System to give you the exact storage you need. Highly customizable and easily relocated, the unique design of this system means it freely adapts to the changing needs of your sterile storage areas or pharmacy.

FrameWRX can accommodate a variety of storage accessories, including hanging plastic bins, pegboard hooks, and slat-wall components—all without tools or fasteners. The system is also available in a high-density option, FrameWRX® HD, which compresses two rows of storage into one deeper space.

For areas where storage is at a premium, FrameWRX HD saves an aisle and gives you additional space.

FrameWRX Applications:

- Pharmacy Storage
- Sterile Supply Storage
- Central Storage
- Operating Room/Surgical Storage





FrameWRX® Available Features Include:

- End panels and canopy tops in an extensive range of colors, finishes, and materials
- Work surfaces in four different shapes and a multitude of sizes
- Unique EZ Rail™ is compatible with hanging bins, pegs, and slat-wall accessories
- Compatible with a wide variety of industry standard bins
- Single-piece wire baskets with divider accessories available
- 2-position adjustable shelves are easy to adjust
- Pass-through shelf available to provide a clear storage area to handle items of all shapes and sizes
- Slat-wall accessories connect to the EZ Rail, allowing for the hanging of a variety of items
- Retractable work surfaces

FrameWRX® HD Available Features Include:

- Built-in handle and bearing-mounted, dual-flange wheels allow for effortless movement of the system's frames, and built-in smooth stopping



PERSONAL STORAGE LOCKERS

Customizable storage lockers.
Better known as your "home away from home."

A locker system that can keep up with the storage needs of your doctors and surgeons, in sizes that fit your space, Spacesaver's DocLock™ Personal Storage Locker is a tough, adaptable long-term solution to your personal storage requirements.

DocLOCK™
PERSONAL STORAGE LOCKER





Standard Features Include:

- Ability to reconfigure on-site, throughout the life of the locker
- Integral garment hanger and peg board holes
- Industry's strongest doors, with 18-gauge, double-wall, welded-box construction
- Hang clothing on the interior door panel by utilizing integrated pegboard holes
- Durable powder-coat paint finish in numerous standard colors
- 9.5" or 13" deep hardwood butcher block bench on bench drawer units
- 200 lb. capacity bench and external access drawers
- Welded 18-gauge cabinet construction, with reinforced corners for added rigidity
- Electrical-ready—add duplex outlets and/or USB chargers to lockers at any time to aid in charging cell phones, tablets, and other personal devices

Available Accessories:

- Full-width adjustable shelves
- Louvered or modular shelves
- Internal drawers
- Lockable box kit for valuables & personal items

HEALTHCARE:

THE APPLICATIONS

OPERATING ROOM & PROCEDURES STORAGE

Create quick and easy access to supplies during critical moments.

During surgery, quick and easy access to sterile supplies is critical. Spacesaver's operating room and procedures storage balances environmental control with ready accessibility to keep you running smoothly—and to maximize storage density in your surgical suite.

Durable shelving options are ergonomically designed to improve visibility, accessibility, or organization of sterile supplies inside and outside the OR.

Drexel University College of Medicine

Philadelphia, Pennsylvania

Improving efficiencies at the Medical College of Pennsylvania's (now the Drexel University College of Medicine) OR suite called for a total redesign. However, something needed to be done with dissimilar sterile supply storage. The solution: centralize with a mobile storage system—and gain efficiencies within the tight confines of the sterile supplies storeroom.

Now, more space is available for advanced equipment and access to supplies is fast and easy. In addition, inventories have been reduced—saving costs for the hospital—and technicians are more efficient and accurate.



Peninsula Regional Medical Center

Salisbury, Maryland

Fumbling through unorganized wire carts to find supplies during surgery simply wasn't acceptable for Peninsula Regional Medical Center—which is why the hospital replaced 70 carts with seven highly-efficient mobile storage systems.

Now, with millions of dollars worth of supplies and instrumentation closer to the action, the staff locates items in seconds, not minutes. Problems with damage to packaging have been eliminated, and the speedy access and better organization translates into a more effective OR team.



Kennestone Regional Medical Center

Marietta, Georgia

With high-tech equipment consuming available space inside its surgical procedure rooms, Kennestone Regional Medical Center needed to put sterile supplies and instruments outside the rooms—yet do so in a way that ensures immediate access to items without the threat of cross-contamination.

The solution took the form of a central supply corridor and uniquely designed high-density mobile storage systems that facilitate quick retrievals and maximize cleanliness. The right storage solution means supplies are where they're needed, when needed—and patients also receive the best possible treatment, thanks to room for state-of-the-art technology.



PHARMACY STORAGE

Organize medications and supplies for optimum visibility and access.

An efficient pharmacy design is crucial to its success—and smart design should always take storage into consideration. With flexible pharmacy shelving options such as FrameWRX® Storage System and high-density mobile storage, we can eliminate your challenges.

We offer solutions that can better organize and manage your medication supply and security and improve workflow by giving your staff fast, direct access to medication storage. This means that as needs change, your storage can adapt right along with them.

Utah State Hospital

Provo, Utah

The Pharmacy Director at Utah State Hospital was excited to move into his new pharmacy—but was surprised to learn that his existing shelving wouldn't be able to make the move because of size constraints. When he realized that a FrameWRX® HD bin shelving system would be able to get him three additional sections of shelving over the five the pharmacy previously had, he was appreciative — but he wanted more. He needed a way for the shelving to be gravity-fed, with the ability to load prescription bottles in the front as well as in the back. He also wanted to make sure he could store bottles of various sizes in the same shelving solution.

Spacesaver's engineering team created custom FrameWRX HD solution, with sloped shelves and dividers spaced 2" apart, allowing for flexibility in bottle size. To create a way to make sure the bottles didn't fall out of the sloped shelves, a sturdy acrylic bin front was designed to support the bottles and provide the visibility the Pharmacy Director needed. The solution maximized the pharmacy's storage, allowing them to increase the bulk storage supply in the room, and the gravity-fed shelf promotes first in, first out (FIFO) inventory management.



Peterborough Medical Center

Peterborough, Ontario

Peterborough's Pharmacy Department set out to create an open-space work environment to ensure high-quality service at its new 424-bed hospital. The situation dictated the need to rethink storage within the busy pharmacy, which led to the installation of the adjustable and ultra-adaptable FrameWRX® Storage System.

The modular system, which can be configured and reconfigured an infinite number of ways on the fly, is exactly what was needed. Quick access to pharmaceuticals and supplies translates into a highly efficient workflow. The system's flexibility also means the solution works around the needs of the pharmacy team—not the other way around—for speedy and accurate delivery of medications for generations to come.





In addition to updated pharmacy storage, the tight confines of a newly constructed narcotics vault drove the need for another unique storage solution. This time, the high-density version of FrameWRX®—FrameWRX® HD—was implemented.

The system boasts not just one, but two rows of interchangeable bins to maximize the use of available space. A built-in, proprietary smooth-stopping device prevents jarring and jolting to safeguard delicate narcotics. With the FrameWRX HD, the pharmacy even has room left over for a workstation and a large refrigerator.



STERILE SUPPLY STORAGE

Improve supply organization
and inventory management.

It might be a bold statement, but we think the organization and efficiency of a hospital's sterile supply rooms are the key to its effectiveness. While the amount and the types of supplies are increasing in these areas, the amount of space to store them is fixed, creating cramped storage that winds up wasting the time of nurses and other personnel.

Spacesaver's flexible sterile supply storage options not only create optimal organization—they take care of security and inventory control as well. This allows important supplies to be located right at the point-of-need®.

Atrium Medical Center

Middletown, Ohio

When Atrium Medical Center was building its new facility, streamlining its strategic management of supplies was top of mind—and they found a unique and highly-efficient system by way of the FrameWRX® Storage System. 20 FrameWRX units, featuring an array of color-coded bins in a variety of sizes, were placed in clean utility rooms on a majority of the facility's patient floors.

The bar-coded bins expedite accurate inventory counts when used in conjunction with hand-held scanners. The new solution nearly doubled the number of supplies stored without having to hire additional full-time staff or incur significant increases in inventory costs.



Virginia Hospital

Norfolk, Virginia

For an award-winning hospital in Virginia, a sterile supply storage solution was needed—but maximizing precious space was also a priority. When the hospital hoped to implement a mobile storage system that could be used within a walk-in cooler, a heavy-duty high-density stainless steel solution was designed.

The stainless steel was to prevent the rust and corrosion usually caused by humidity and temperature, as well as being a logical choice for its easy-clean abilities. A dual control for the mobile system was installed for access at both ends, and the result is a cooler space that not only ensures an uncontaminated environment, but also a sizeable increase in storage space.

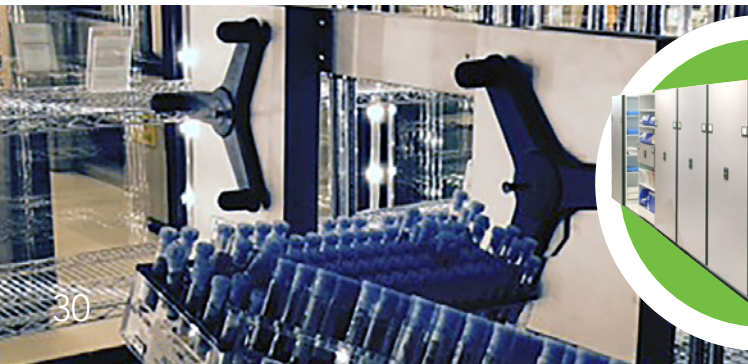

Naval Medical Center

San Diego, California

The Naval Medical Center in San Diego, California is considered the most technologically-advanced U.S. Navy medical treatment facility. However, the Center's storage wasn't making the grade, due to the fact that the majority of the facility's sterile storage supplies were kept in a basement. To restock, medical staff would have to load up supply carts in the basement, cart them into a utility elevator, and then take them to a smaller supply area.

Several high-density mobile systems with wire shelving and plastic bins were installed, which integrated with plastic walls and negative-pressure devices with HEPA filtration to protect the sterile environment. The new system created additional medical supply storage capacity—and allowed the Center to centralize their sterile supplies where they were needed and depend less on basement storage.





CREATING A PARTNERSHIP

In addition to these areas, we've also assisted with storage solutions for:

- Clinical Labs & Diagnostic Imaging
- Linens
- Food Services
- Materials Management
- Health Information Management
- Business Office & Human Resources
- Admitting & Discharging

For additional examples of how we've solved healthcare storage challenges, visit www.spacesaver.com—then head to our Photo Gallery and filter by “Healthcare” to take a closer look.

It takes a team to successfully build, renovate, or expand a healthcare center. Because a well-designed storage system forms the core of an effective facility, storage should be one of the primary considerations as the planning process begins. Our local distributors routinely collaborate with healthcare professionals and the architects, contractors, and interior designers on their teams, working in partnership to create practical and aesthetically pleasing storage solutions.

So, whether you're dealing with a lack of space for supplies in your operating room, sterile supply, pharmacy areas, or patient rooms, we can help.

Call us at **800.492.3434** or visit us at www.spacesaver.com.



Serving Oregon and SW Washington

Spacesaver Specialists, Inc.
9730 SW Herman Road
Tualatin, OR 97062
503.612.2600
www.storageplanning.com



Spacesaver Corporation 1450
Janesville Avenue
Fort Atkinson, WI 53538-2798
800.492.3434
www.spacesaver.com